

## WIDEBAND MMIC VCO w/ BUFFER AMPLIFIER, 4 - 8 GHz

### Typical Applications

Low Noise wideband MMIC VCO is ideal for:

- Industrial/Medical Equipment
- Test & Measurement Equipment
- Military Radar, EW & ECM

### Features

- Wide Tuning Bandwidth
- Pout: +5 dBm
- Low SSB Phase Noise: -100 dBc/Hz @100 kHz
- No External Resonator Needed
- Single Positive Supply: +5V @ 55 mA
- RoHS Compliant 4 x 4 mm SMT Package

### Functional Diagram

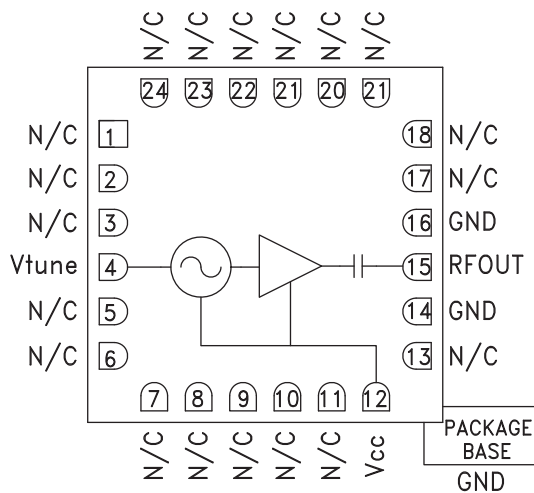

### General Description

The HMC586LC4B is a wideband GaAs InGaP Voltage Controlled Oscillator which incorporates the resonator, negative resistance device, and varactor diode. Output power and phase noise performance are excellent over temperature due to the oscillator's monolithic construction. The Vtune port accepts an analog tuning voltage from 0 to +18V. The HMC586LC4B VCO operates from a single +5V supply, consumes only 55 mA of current, and is housed in a RoHS compliant SMT package. This wideband VCO uniquely combines the attributes of ultra small size, low phase noise, low power consumption, and wide tuning range.

### Electrical Specifications, $T_A = +25^\circ\text{C}$ , $V_{cc} = +5\text{V}$

Parameter	Min.	Typ.	Max.	Units
Frequency Range	4.0 - 8.0			GHz
Power Output	2	5		dBm
SSB Phase Noise @ 100 kHz Offset		-100		dBc/Hz
SSB Phase Noise @ 10 kHz Offset		-75		dBc/Hz
Tune Voltage (Vtune)	0		18	V
Supply Current (Icc) (Vcc = +5.0V)	40		75	mA
Tune Port Leakage Current (Vtune = +15V)			10	$\mu\text{A}$
Output Return Loss		7		dB
2nd Harmonic		-14		dBc
Pulling (into a 2.0:1 VSWR)		4		MHz pp
Pushing @ Vtune = +5V		40		MHz/V
Frequency Drift Rate		0.8		MHz/ $^\circ\text{C}$



**WIDEBAND MMIC VCO w/ BUFFER  
AMPLIFIER, 4 - 8 GHz**

**Frequency vs. Tuning Voltage, Vcc = +5V**

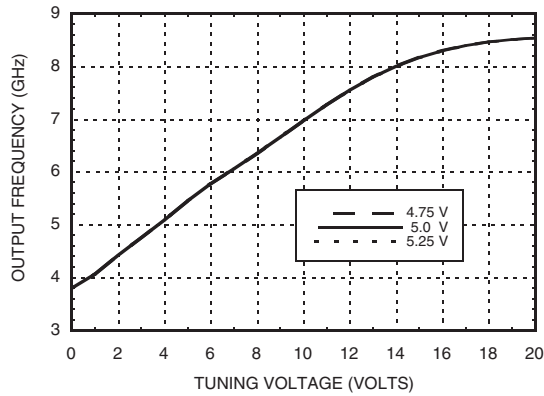

**Frequency vs. Tuning Voltage, T = +25 C**

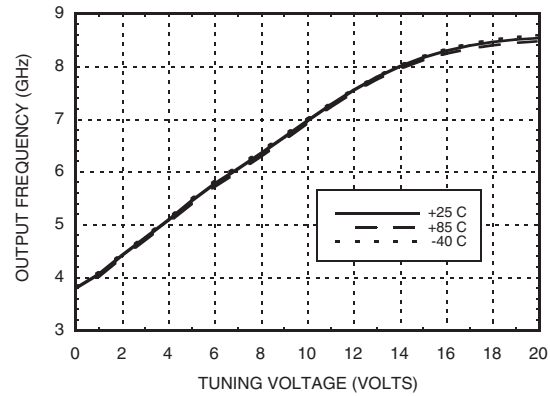

**Sensitivity vs. Tuning Voltage, Vcc= +5V**

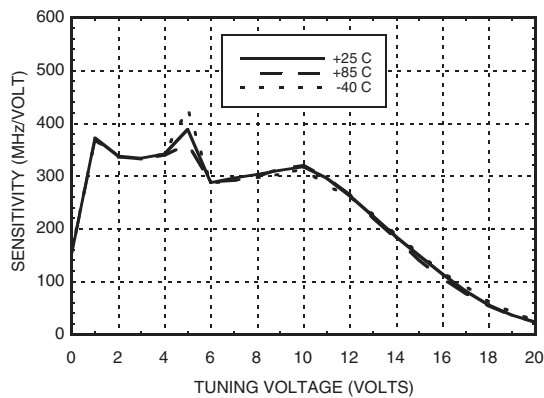

**Output Power vs.  
Tuning Voltage, Vcc= +5V**

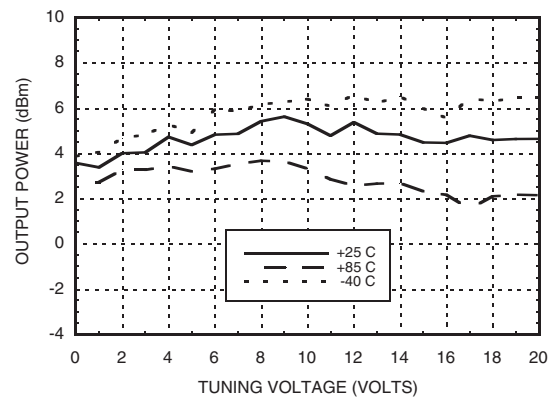

**SSB Phase Noise vs. Tuning Voltage**

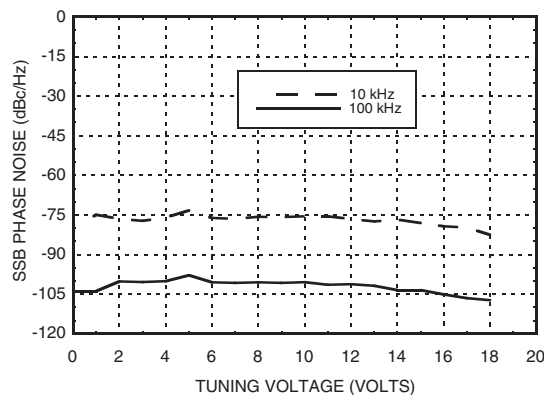

**Typical SSB Phase Noise @ Vtune= +5V**

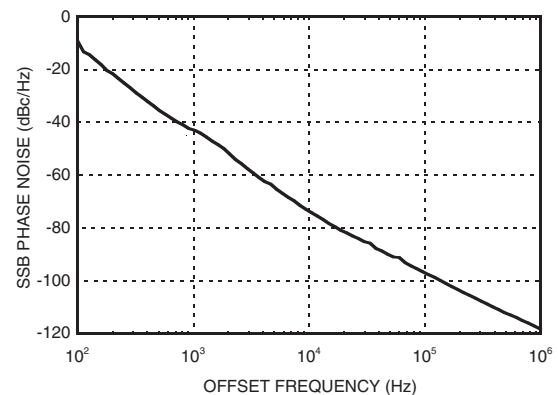

### Absolute Maximum Ratings

Vcc	+5.5 Vdc
Vtune	0 to +22V
Junction Temperature	135 °C
Continuous Pdiss (T = 85°C) (derate 12.5 mW/°C above 85°C)	625 mW
Thermal Resistance (junction to ground paddle)	80 °C/W
Storage Temperature	-65 to +150 °C
Operating Temperature	-40 to +85 °C



ELECTROSTATIC SENSITIVE DEVICE  
OBSERVE HANDLING PRECAUTIONS

### Outline Drawing

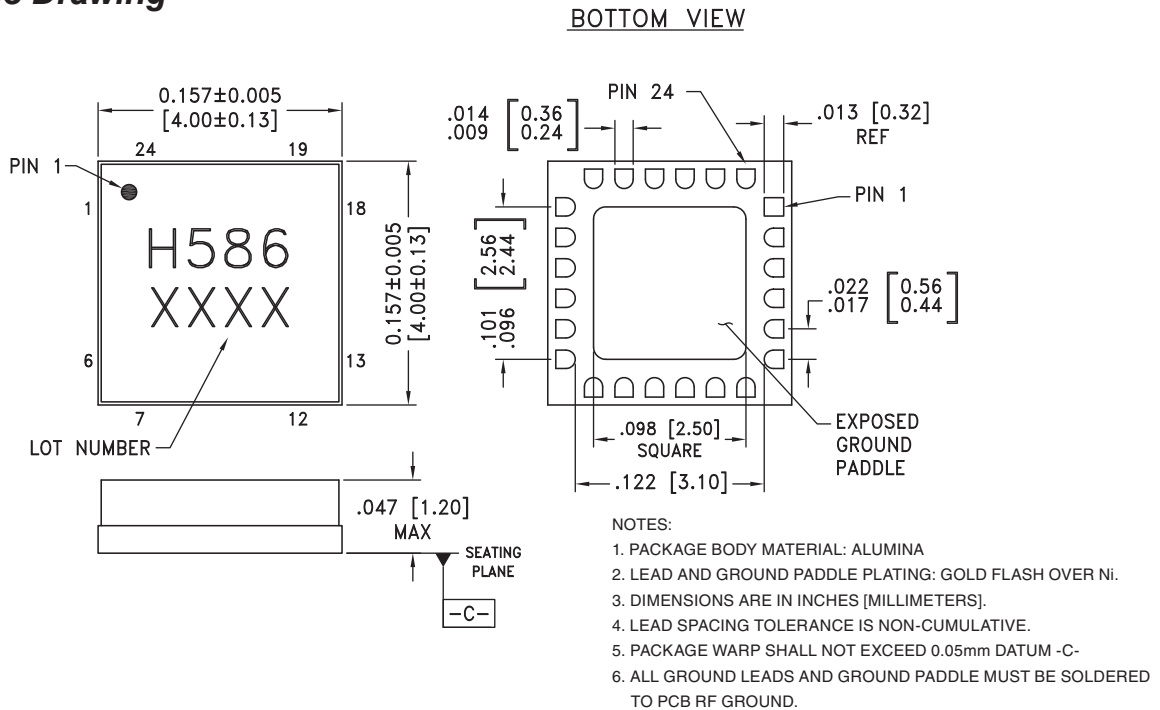

### Pin Descriptions

Pin Number	Function	Description	Interface Schematic
1 - 3, 5 - 11, 13, 17 - 24	N/C	No Connection. These pins may be connected to RF/DC ground. Performance will not be affected.	
4	Vtune	Control Voltage and Modulation Input. Modulation bandwidth dependent on drive source impedance. See "Determining the FM Bandwidth of a Wideband Varactor Tuned VCO" application note.	
12	Vcc	Supply Voltage Vcc= +5V	

### Pin Descriptions

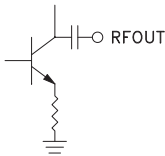
Pin Number	Function	Description	Interface Schematic
14, 16	GND	Package bottom has an exposed metal paddle that must also be RF & DC grounded.	
15	RFOUT	RF output (AC coupled)	

### Evaluation PCB

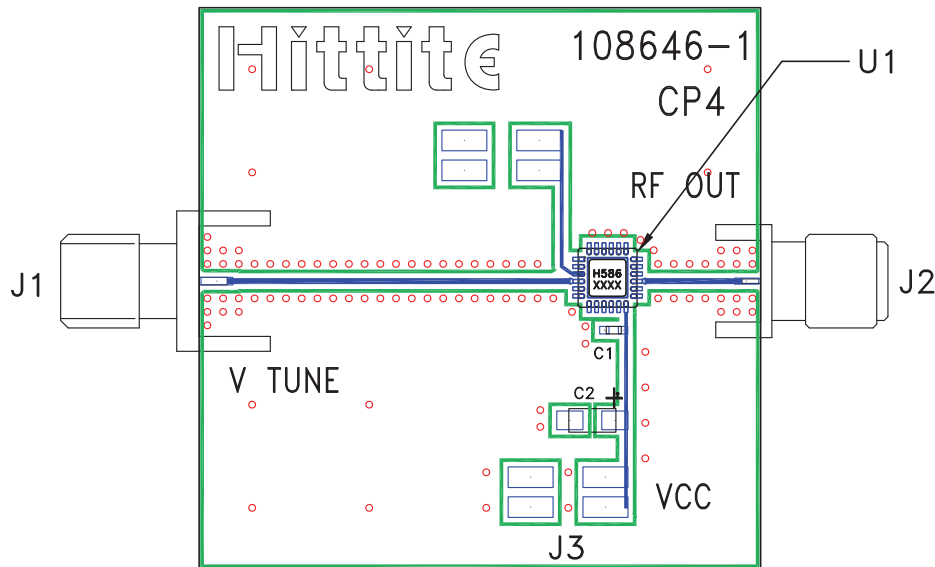

### List of Materials for Evaluation PCB 108648 <sup>[1]</sup>

Item	Description
J1	PCB Mount SMA RF Connector, Johnson
J2	PCB Mount SMA Connector, SRI
J3	DC Header
C1	1000 pF Capacitor, 0402 Pkg.
C2	4.7 μF Capacitor, Tantalum
U1	HMC586LC4B VCO
PCB <sup>[2]</sup>	108646 Eval Board

[1] Reference this number when ordering complete evaluation PCB

[2] Circuit Board Material: Rogers 4350

The circuit board used in the final application should use RF circuit design techniques. Signal lines should have 50 ohm impedance while the package ground leads and exposed ground paddle should be connected directly to the ground plane similar to that shown. A sufficient number of via holes should be used to connect the top and bottom ground planes. The evaluation circuit board shown is available from Hittite upon request.